



TECHNICAL CATALOGUE

YORK[®] CHECK AND FOOT VALVES



> THE COMPANY

ITAP SpA, founded in Lumezzane (Brescia) in 1972, is currently one of the leading production companies in Italy of **valves, fittings and distribution manifolds** for plumbing and heating systems.

Thanks to a fully automated production process, with 85 transfer machines and 55 assembly lines, it is capable of producing 400,000 pieces per day.

Our innate pursuit for innovation and observance of technical regulations is supported by the company certification ISO 9001. The company has always considered its focus on quality as the main tool to obtain significant business results: today ITAP SpA is proud to offer products bearing the approval of numerous international certifying bodies.

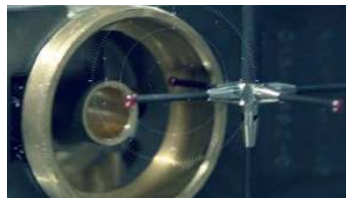
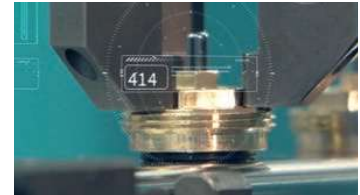

> ITAP products have obtained approvals by more than 30 certification bodies from all over the world.





YORK® CHECK AND FOOT VALVES

103 YORK® check valve

Suitable for domestic water services, heating, air-conditioning plants and compressed air systems. They can be installed in any position: vertical, horizontal, oblique.



MEASURE	PRESSURE	CODE	PACKING
3/8" (DN 10)	12bar/174psi	1030038	10/200
1/2" (DN 15)	12bar/174psi	1030012	10/170
3/4" (DN 20)	12bar/174psi	1030034	8/120
1" (DN 25)	12bar/174psi	1030100	8/88
1 1/4" (DN 32)	10bar/145psi	1030114	6/60
1 1/2" (DN 40)	10bar/145psi	1030112	4/28
2" (DN 50)	10bar/145psi	1030200	2/24
2 1/2" (DN 65)	8bar/116psi	1030212	1/16
3" (DN 80)	8bar/116psi	1030300	1/8
4" (DN 100)	8bar/116psi	1030400	1/4

CERTIFICATIONS



TECHNICAL SPECIFICATIONS

Body in brass.

Plate in polymer.

Washer in NBR.

Spring: stainless steel.

Minimum and maximum working temperatures: -20°C, 100°C.

Threads: ISO 228 (equivalent to DIN EN ISO 228 and BS EN ISO 228).

ACS approved in sizes from 3/8" to 2".



YORK® CHECK AND FOOT VALVES

OVERALL DIMENSIONS

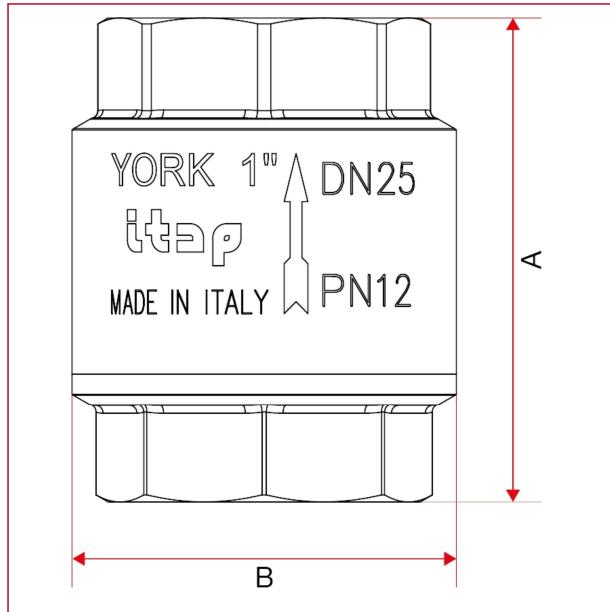

	3/8"	1/2"	3/4"	1"	1"1/4	1"1/2	2"	2"1/2	3"	4"
DN	10	15	20	25	32	40	50	65	80	100
A	46,5	48	53	60,5	66,5	74	80,5	98	103	118,5
B	35	35	42	48	59,5	70,5	86	103	126	154
Kg/cm2 bar	12	12	12	12	10	10	10	8	8	8
LBS - psi	174	174	174	174	145	145	145	116	116	116



YORK® CHECK AND FOOT VALVES

MATERIALS

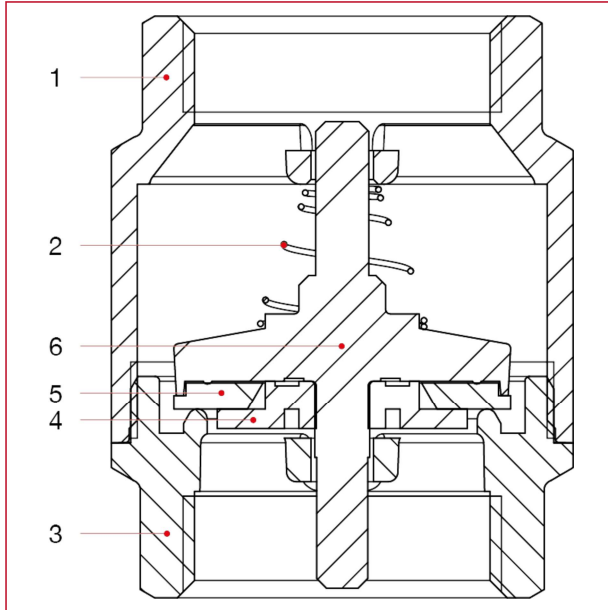

POS.	DESCRIPTION	N.	MATERIAL
1	Body	1	Brass CW617N
2	Spring	1	Stainless steel AISI 302
3	End adapter	1	Brass CW617N
4	Pin	1	Polymer
5	Washer	1	NBR
6	Plate	1	Polymer



YORK[®] CHECK AND FOOT VALVES

INSTALLATION

The YORK[®] check valves are uni-directional; that means they manage the flow in one direction only, which is indicated by the arrow on the body.

The valves are composed by a spring, a little valve and a couple of parts made of brass (body and end-adapter) which contain them and that are assembled but means of thread and a sealed material to obtain their aim.

In order to avoid that the sealed material gets broken and then the valve loses the connection between the body and the end-adapter, it's necessary to avoid to submit the two parts under the influence of a torque.

For the installation normal hydraulic practices must be used, and especially:

- for a proper installation of the valve, near curves and circulation pumps, the valve must be mounted at a distance equal to 10 times the diameter of the pipe.
- ones have to be sure that the two pipes are correctly aligned;
- during the assembling process the installer has to apply its assembling tools at the end that is nearest to the pipe;
- the application of the sealing materials by the fitter (PTFE or hempen cloth) must be limited at the thread zone. An excess should interfere in the rubber-metal sealing zone, compromising the tightness;
- in case the fluid transported has got some impurities (dust, too hard water, and so on) it's necessary to remove impurities by or filter them, otherwise they could damage the seal.

DISASSEMBLY

To remove the valve from the pipe line or anyhow before to unscrew the junctions linked to it:

- wear the protective clothing normally required to work with carried fluids;
- Depressurize the line;
- During the disassembling process, apply the key at the end of the valve, the one nearest the pipe.

MAINTENANCE

Verify the valves periodically, in function of their application's field and in function of their work conditions, to be sure that the valves work correctly.

In case of losses of tightening, take note that these can be caused by a deposit of foreign bodies (dirty, calcareous) on the rubber seal.

In order to solve this inconvenient, it's necessary to unmount the valve and remove the foreign body with compressed air tools.



YORK® CHECK AND FOOT VALVES

LOSS DIAGRAM (With water)

	3/8"	1/2"	3/4"	1"	1"1/4"	1"1/2"	2"	2"1/2"	3"	4"
KV	2,11	4,22	7,92	11,67	22,42	29,39	51,40	69,90	98,49	157,91

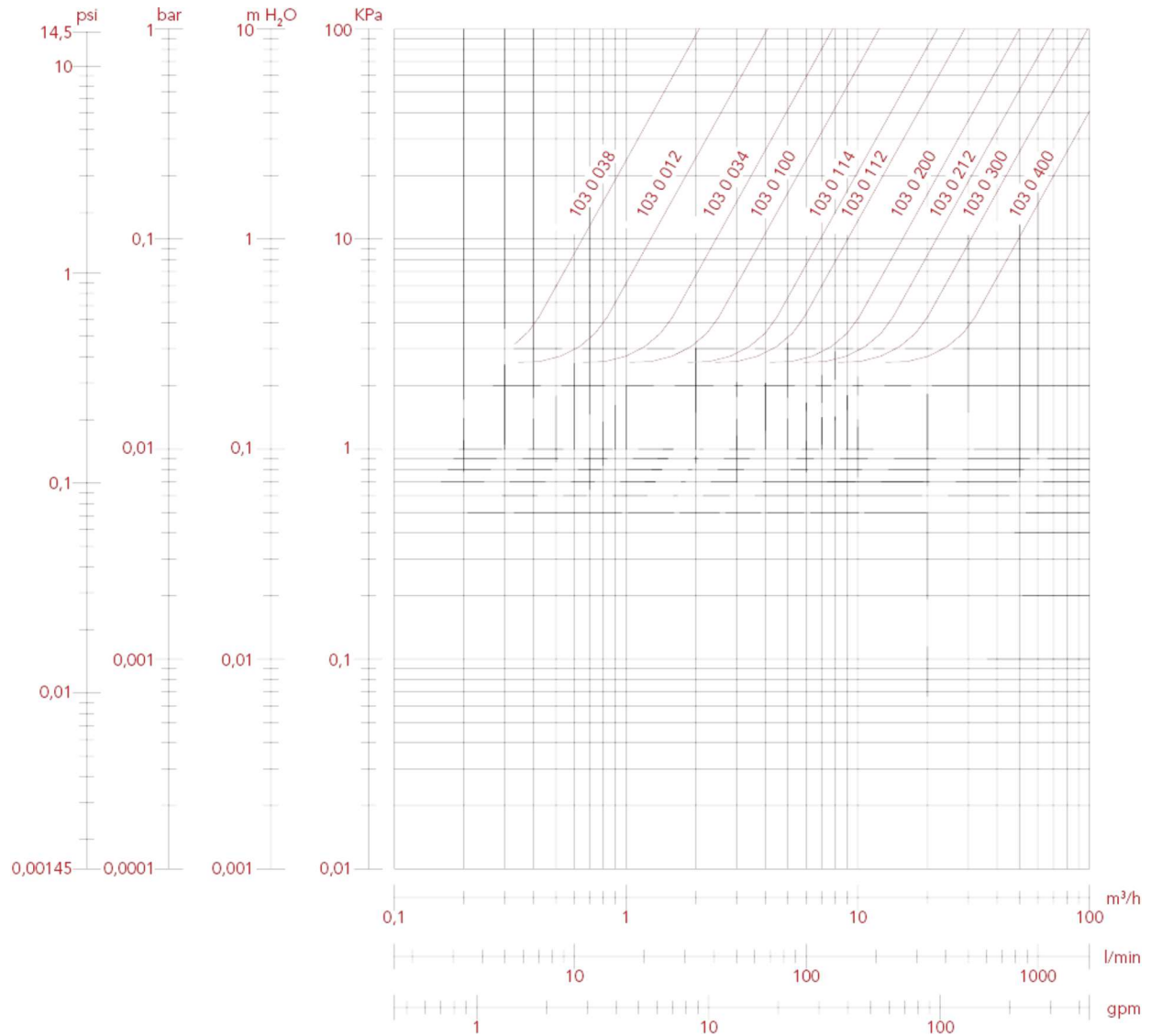



YORK[®] CHECK AND FOOT VALVES

DIAGRAM OF THE MINIMUM PRESSURE NEEDED TO GET THE VALVES OPENING

The opening of the valve is given by the different pressure between the two sides of the seat.

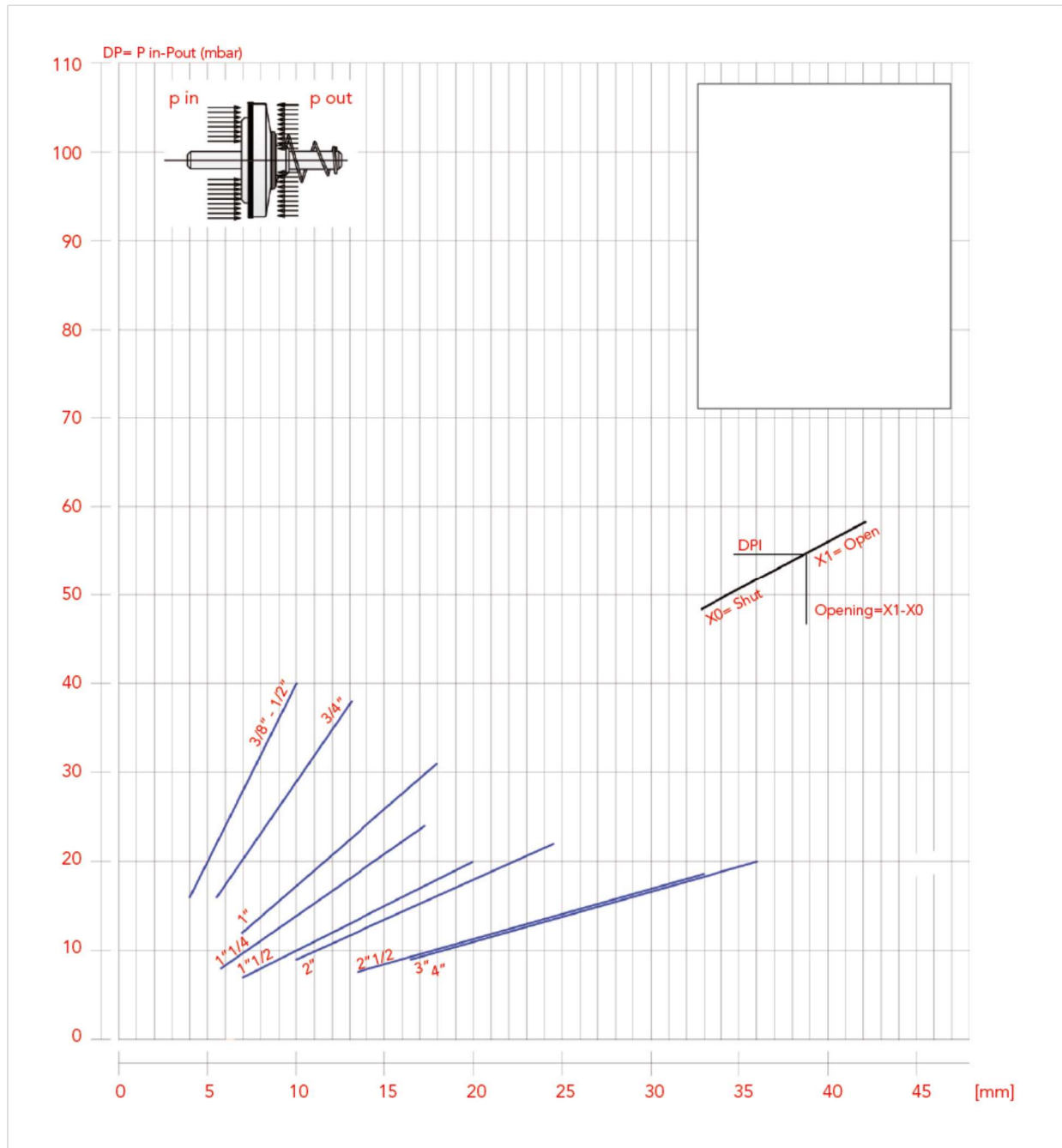



YORK[®] CHECK AND FOOT VALVES

PRESSURE-TEMPERATURE DIAGRAM

The values shown by the dropping lines state the maximum limit of employment of the valves.
The shown values are approximate.

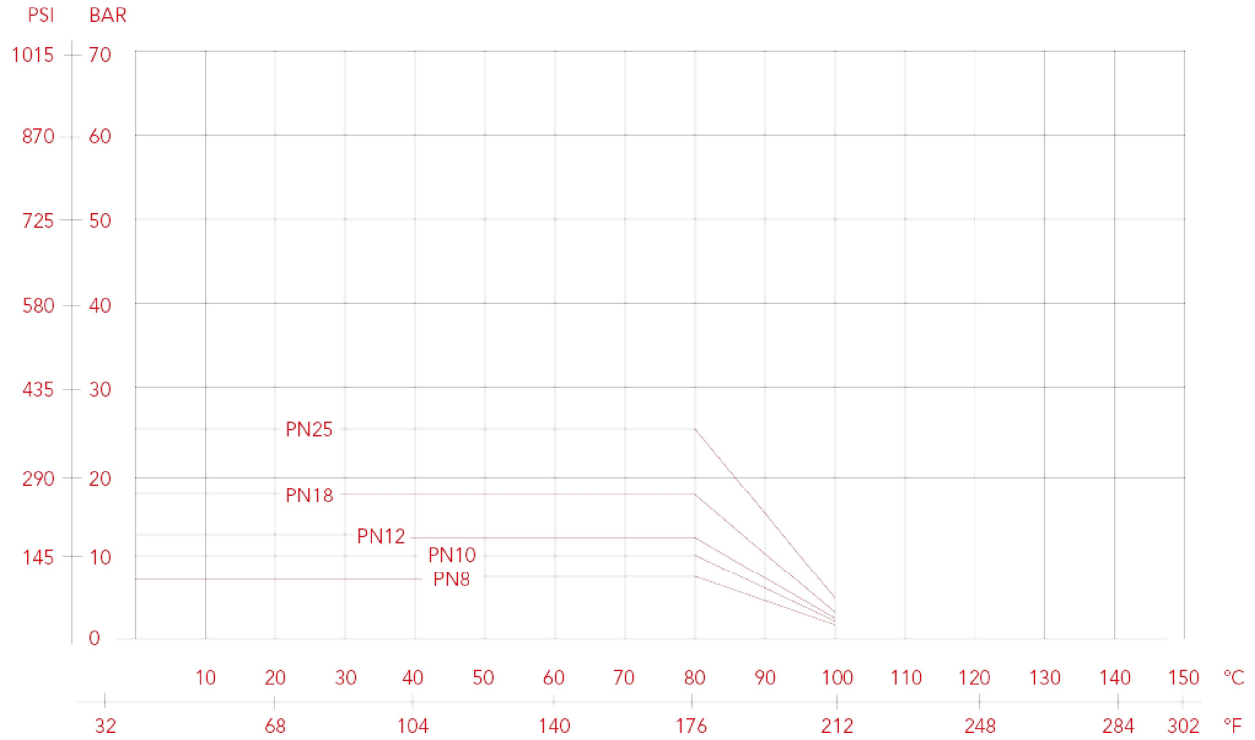



ITAP S.p.A.

Via Ruca 19

25065 Lumezzane

Brescia (ITALY)

Tel 030 8927011

Fax 030 8921990

www.itap.it - info@itap.it

We reserve the right to make improvements and changes to the products described herein and to the relative technical data, at any time and without forewarning.

rev. 20241216